

GPS/GNSS Low-Noise Amplifiers

General Description

The MAX2657/MAX2658 high-gain, low-noise amplifiers (LNAs) are designed for GPS L1, Galileo, and GLONASS applications. Designed in Maxim's advanced SiGe process, the devices achieve a high gain and an ultra-low-noise figure while maximizing the input-referred 1dB compression point and the 3rd-order intercept point.

The MAX2657/MAX2658 operate from a +1.6V to +3.3V single supply. The MAX2657 is optimized for low current. The MAX2658 is optimized for high linearity. The shut-down feature in the device reduces the supply current to be less than 1 μ A. The MAX2657/MAX2658 are available in a very small, lead-free, RoHS-compliant, 0.86mm x 1.26mm x 0.65mm, wafer-level package (WLP).

Applications

Automotive Navigation
Location-Enabled Mobile Devices
Telematics (Asset Tracking and Management)
Personal Navigation Devices (PNDs)
Cellular Phones with GPS
Notebook PCs/Ultra-Mobile PCs
Recreational, Marine Navigation
Avionics
Watches

Features

- ◆ High-Power Gain: 19dB (MAX2657)
- ◆ Ultra-Low-Noise Figure: 0.8dB
- ◆ Integrated 50 Ω Output Matching Circuit
- ◆ Low Supply Current: 4.1mA (MAX2657)
- ◆ Wide Supply Voltage Range: 1.6V to 3.3V
- ◆ Low Bill of Materials: One Inductor, Two Capacitors
- ◆ Small Footprint: 0.86mm x 1.26mm
- ◆ Thin Profile: 0.65mm
- ◆ 0.4mm-Pitch Wafer-Level Package (WLP)

Ordering Information

PART	TEMP RANGE	PIN-PACKAGE
MAX2657EWT+T	-40°C to +85°C	6 WLP
MAX2658EWT+T	-40°C to +85°C	6 WLP

+ Denotes a lead(Pb)-free/RoHS-compliant package.
T = Tape and reel.

Pin Configuration/Typical Application Circuit

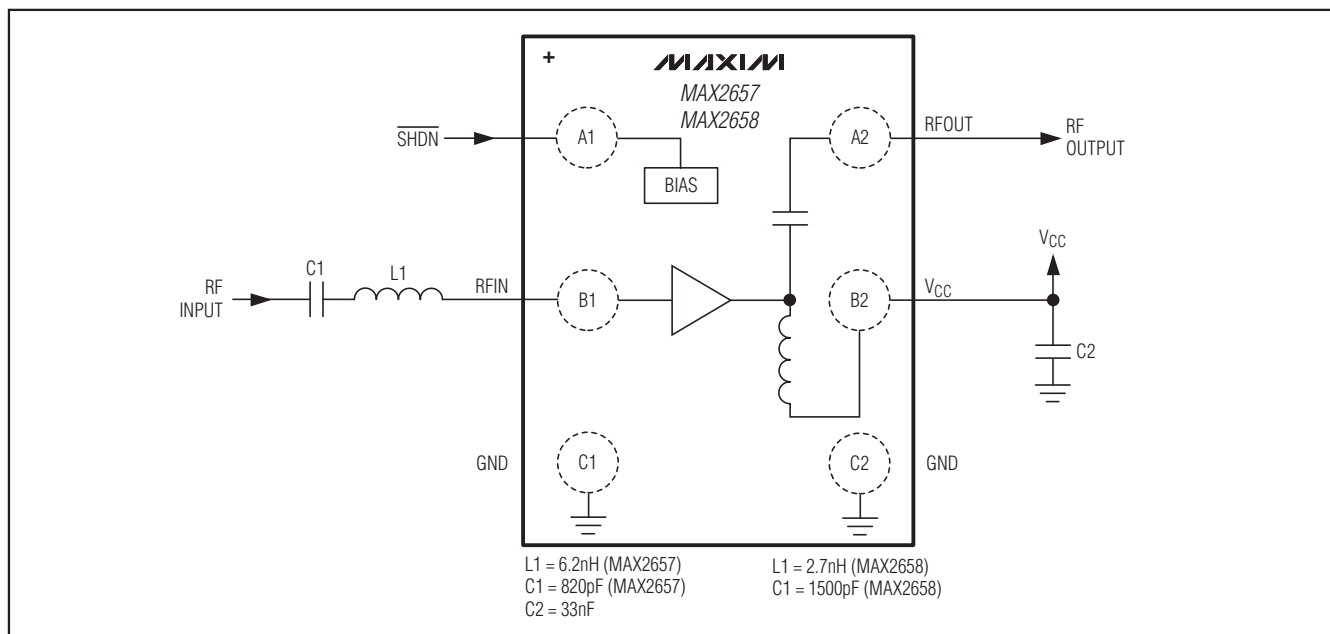

GPS/GNSS Low-Noise Amplifiers

ABSOLUTE MAXIMUM RATINGS

V _{CC} to GND	-0.3V to +3.6V	Maximum Current into RF Input	10mA
Other Pins to GND	-0.3V to (+ Operating V _{CC} + 0.3V)	Operating Temperature Range	-40°C to +85°C
Maximum RF Input Power	+5dBm	Junction Temperature	+150°C
Continuous Power Dissipation (T _A = +70°C)		Storage Temperature Range	-65°C to +160°C
6-Bump WLP (derates 10.5mW/°C above +70°C).....	840mW	Lead Temperature (soldering, 10s).....	Reflow Profile (Note 1)

Note 1: Refer to Application Note 1891: *Wafer-Level Packaging (WLP) and Its Applications*.

 **CAUTION!** ESD SENSITIVE DEVICE

Stresses beyond those listed under "Absolute Maximum Ratings" may cause permanent damage to the device. These are stress ratings only, and functional operation of the device at these or any other conditions beyond those indicated in the operational sections of the specifications is not implied. Exposure to absolute maximum rating conditions for extended periods may affect device reliability.

DC ELECTRICAL CHARACTERISTICS

(MAX2657/MAX2658 EV kit. V_{CC} = 1.6V to 3.3V, T_A = -40°C to +85°C, no RF signals are applied. Typical values are at V_{CC} = 2.85V and T_A = +25°C, unless otherwise noted.) (Note 2)

PARAMETER	CONDITIONS		MIN	TYP	MAX	UNITS
Supply Voltage			1.6	2.85	3.3	V
Supply Current	SHDN = high	MAX2657	4.1			mA
		MAX2658	7.7			
	Shutdown mode, SHDN = low				1	μA
Digital Input Logic-High			1.2			V
Digital Input Logic-Low					0.45	V
Digital Input Current					1	μA

AC ELECTRICAL CHARACTERISTICS

(MAX2657/MAX2658 EV kit. V_{CC} = 1.6V to 3.3V, T_A = -40°C to +85°C, f_{RFIN} = 1575.42MHz. Typical values are at V_{CC} = 2.85V and T_A = +25°C, unless otherwise noted.) (Note 2)

PARAMETER	CONDITIONS		MIN	TYP	MAX	UNITS
RF Frequency	L1 band		1575.42			MHz
Power Gain	V _{CC} = 2.85V	MAX2657	19.5			dB
		MAX2658	17.7			
	V _{CC} = 1.6V	MAX2657	19.4			
		MAX2658	17.6			
Noise Figure	V _{CC} = 1.8V		0.8			dB
	V _{CC} = 3.3V		0.8			
In-Band 3rd-Order Input Intercept Point	(Note 3)	MAX2657	-3.5			dBm
		MAX2658	+4.5			
Out-of-Band 3rd-Order Input Intercept Point	(Note 4)	MAX2657	+2.5			dBm
		MAX2658	+8			

GPS/GNSS Low-Noise Amplifiers

MAX2657/MAX2658

AC ELECTRICAL CHARACTERISTICS (continued)

(MAX2657/MAX2658 EV kit. $V_{CC} = 1.6V$ to $3.3V$, $T_A = -40^{\circ}C$ to $+85^{\circ}C$, $f_{RFIN} = 1575.42MHz$. Typical values are at $V_{CC} = 2.85V$ and $T_A = +25^{\circ}C$, unless otherwise noted.) (Note 2)

PARAMETER	CONDITIONS	MIN	TYP	MAX	UNITS
Input 1dB Compression point	(Note 5)	MAX2657	-12.5		dBm
		MAX2658	-10		
Input Return Loss			10		dB
Output Return Loss			15		dB
Reverse Isolation			30		dB

Note 2: Min and max limits guaranteed by test at $T_A = +85^{\circ}C$ and guaranteed by design and characterization at $T_A = -40^{\circ}C$ and $T_A = +25^{\circ}C$.

Note 3: Measured with the two tones located at 1MHz and 2MHz offset from the center of the GPS band with -30dBm/tone for MAX2657 and -27dBm/tone for MAX2658.

Note 4: Measured with input tones at 1713MHz (-25dBm) and 1851MHz (-49dBm).

Note 5: Measured with a tone located at 5MHz offset from the center of the GPS band.

Typical Operating Characteristics

(MAX2657/MAX2658 EV kit. Typical values are at $V_{CC} = 2.85V$, $T_A = +25^{\circ}C$, and $f_{RFIN} = 1575.42MHz$, unless otherwise noted.)

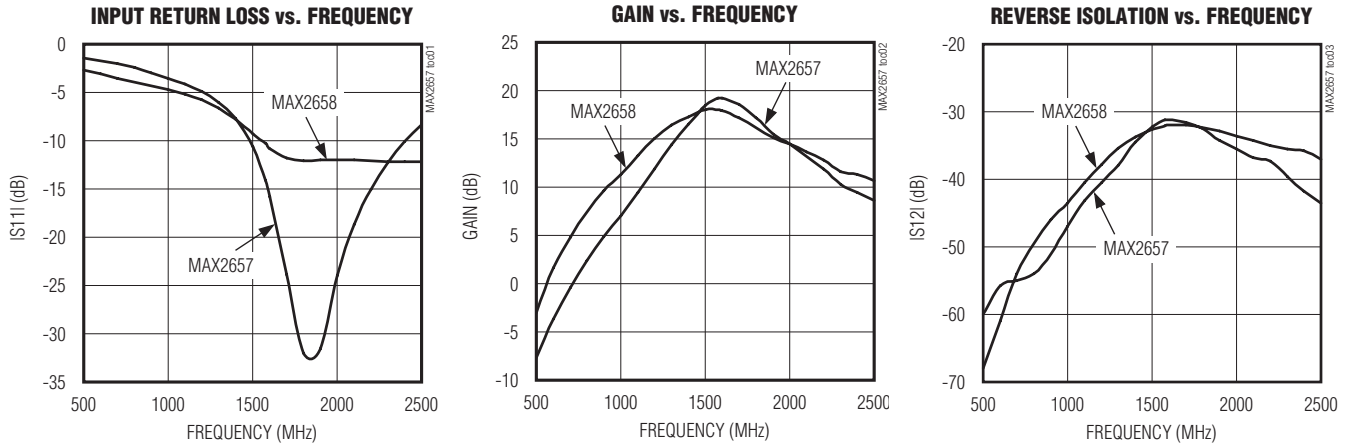

GPS/GNSS Low-Noise Amplifiers

Typical Operating Characteristics (continued)

(MAX2657/MAX2658 EV kit. Typical values are at $V_{CC} = 2.85V$, $T_A = +25^\circ C$, and $f_{RFIN} = 1575.42MHz$, unless otherwise noted.)

OUTPUT RETURN LOSS vs. FREQUENCY

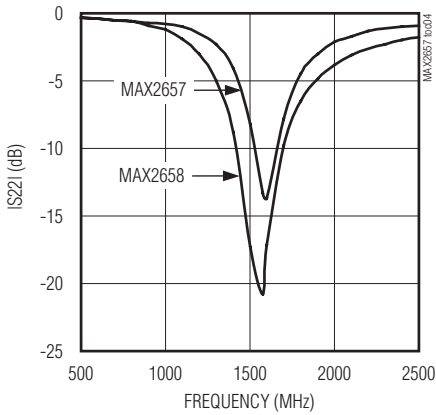

MAX2657 IN-BAND IIP3 vs. SUPPLY VOLTAGE AND TEMPERATURE (TWO TONES LOCATED AT 1MHz AND 2MHz OFFSET WITH -35dBm/TONE)

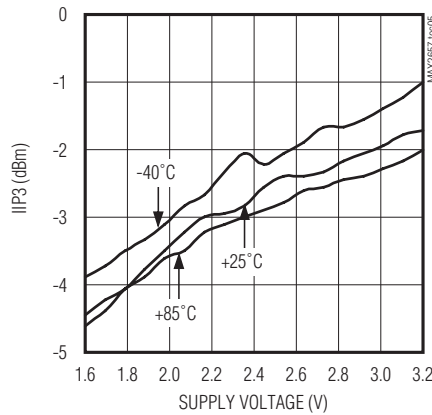

MAX2658 IN-BAND IIP3 vs. SUPPLY VOLTAGE AND TEMPERATURE (TWO TONES LOCATED AT 1MHz AND 2MHz OFFSET WITH -30dBm/TONE)

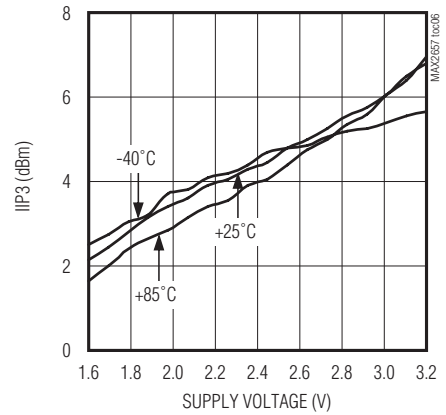

MAX2657 OUT-OF-BAND IIP3 vs. SUPPLY VOLTAGE AND TEMPERATURE (TONE 1 AT 1713MHz, -25dBm; TONE 2 AT 1851MHz, -49dBm)

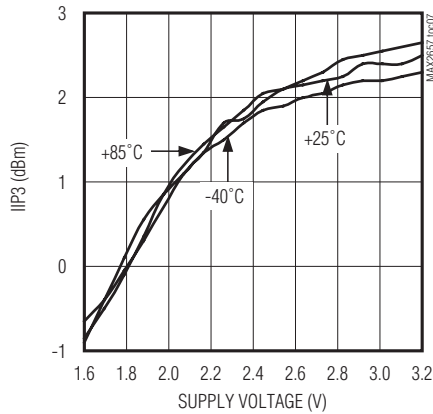

MAX2658 OUT-OF-BAND IIP3 vs. SUPPLY VOLTAGE AND TEMPERATURE (TONE 1 AT 1713MHz, -25dBm; TONE 2 AT 1851MHz, -49dBm)

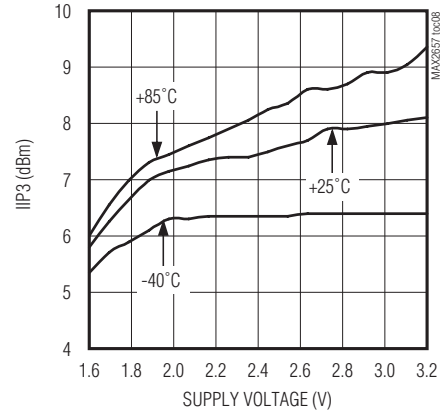

GPS/GNSS Low-Noise Amplifiers

Typical Operating Characteristics (continued)

(MAX2657/MAX2658 EV kit. Typical values are at $V_{CC} = 2.85V$, $T_A = +25^\circ C$, and $f_{RFIN} = 1575.42MHz$, unless otherwise noted.)

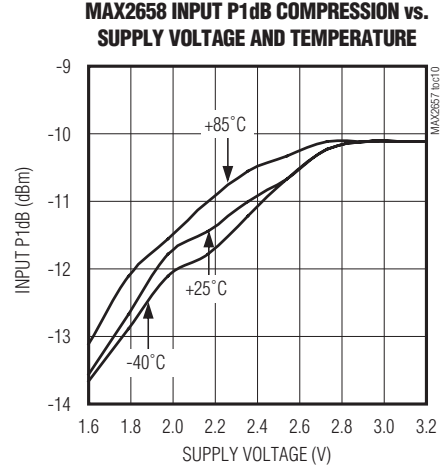
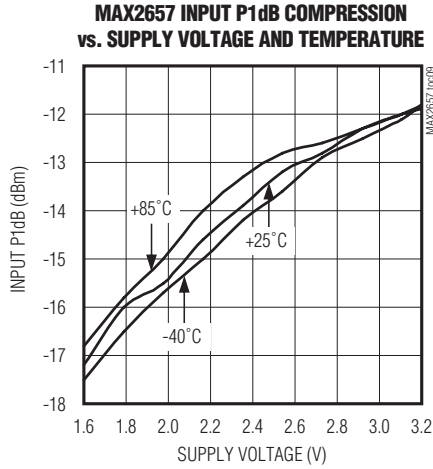

MAX2657/MAX2658

GPS/GNSS Low-Noise Amplifiers

Pin Description

BUMP	NAME	FUNCTION
A1	$\overline{\text{SHDN}}$	Shutdown Input. A logic-low disables the device.
A2	RFOUT	RF Output. RFOUT is internally matched to 50 Ω and incorporates an internal DC-blocking capacitor.
B1	RFIN	RF Input. Requires a DC-blocking capacitor and external matching components.
B2	V _{CC}	Supply Voltage. Bypass to ground with a 33nF capacitor as close as possible to the IC.
C1, C2	GND	Ground. Connect to the PCB ground plane.

Detailed Description

The MAX2657/MAX2658 are LNAs designed for GPS L1, Galileo, and GLONASS applications. The devices feature a power-shutdown control mode to eliminate the need for an external supply switch. The devices achieve a high gain and an ultra-low-noise figure.

Input and Output Matching

The MAX2657/MAX2658 require an off-chip input matching. Only an inductor in series with a DC-blocking capacitor is needed to form the input matching circuit. The *Typical Application Circuit* shows the recommended input-matching network. These values are optimized for the best simultaneous gain, noise figure, and return loss performance. Tables 1 and 2 list typical device S parameters and K_f values. The MAX2657/MAX2658 integrate an on-chip output matching to 50 Ω at the output, eliminating the need for external matching components. The value of the input coupling capacitor affects IIP3. A smaller coupling capacitor results in lower IIP3.

Shutdown

The MAX2657/MAX2658 include a shutdown feature to turn off the entire chip. Apply a logic-high to the $\overline{\text{SHDN}}$ pin to place the part in the active mode, and a logic-low to place the part in the shutdown mode.

Applications Information

A properly designed PCB is essential to any RF microwave circuit. Use controlled-impedance lines on all high-frequency inputs and outputs. Bypass V_{CC} with decoupling capacitors located close to the device. For long V_{CC} lines, it may be necessary to add decoupling capacitors. Locate these additional capacitors further away from the device package. Proper grounding of the GND pins is essential. If the PCB uses a topside RF ground, connect it directly to the GND pins. For a board where the ground is not on the component layer, connect the GND pins to the board with multiple vias close to the package.

Table 1. MAX2657 Typical S-Parameter Values and K-Factor

FREQ. (MHz)	S11 MAG (dB)	S11 PHASE (Degrees)	S21 MAG (dB)	S21 PHASE (Degrees)	S12 MAG (dB)	S12 PHASE (Degrees)	S22 MAG (dB)	S22 PHASE (Degrees)	K _f
1000	-2.0	-47.7	6.0	-100.0	-47.5	-148.0	-1.0	-55.0	5.1
1100	-2.1	-48.6	7.4	-100.6	-45.7	-150.0	-1.0	-58.1	3.8
1200	-2.2	-51.6	9.6	-107.3	-42.9	-153.5	-1.4	-65.4	3.1
1300	-2.4	-55.0	12.0	-117.2	-39.6	-160.2	-2.1	-74.1	2.5
1400	-2.7	-58.6	14.0	-129.5	-37.0	-168.5	-3.6	-85.5	2.3
1500	-6.5	-61.9	16.2	-146.5	-34.1	178.5	-7.4	-100.0	2.8
1575	-4.3	-62.3	17.1	-164.2	-32.9	162.8	-15.3	-100.8	2.1
1600	-4.6	-61.6	17.3	-170.6	-32.8	156.6	-20.6	-78.9	2.0
1700	-5.4	-55.3	17.1	165.5	-32.5	136.5	-9.5	10.0	1.8
1800	-5.2	-49.8	15.7	145.8	-33.8	121.6	-4.5	-2.4	1.6
1900	-4.8	-47.3	13.9	135.2	-35.2	113.8	-2.7	-13.2	1.6
2000	-4.5	-46.7	12.7	127.3	-36.7	109.6	-1.8	-21.2	1.5

GPS/GNSS Low-Noise Amplifiers

MAX2657/MAX2658

Table 2. MAX2658 Typical S-Parameter Values and K-Factor

FREQ. (MHz)	S11 MAG (dB)	S11 PHASE (Degrees)	S21 MAG (dB)	S21 PHASE (Degrees)	S12 MAG (dB)	S12 PHASE (Degrees)	S22 MAG (dB)	S22 PHASE (Degrees)	K _f
1000	-3.0	-57.0	10.8	-120.0	-43.0	-154.0	-1.3	-65.0	3.2
1100	-3.3	-58.2	11.6	-124.5	-42.1	-155.0	-1.6	-70.2	3.3
1200	-3.5	-60.0	13.4	-134.6	-39.3	-160.5	-2.4	-79.6	2.8
1300	-3.8	-62.3	14.9	-148.0	-37.2	-168.3	-4.0	-90.0	2.7
1400	-4.3	-63.3	15.9	-162.3	-35.4	-178.2	-7.3	-101.0	2.7
1500	-4.9	-62.0	16.6	-178.9	-33.9	171.0	-14.5	-100.6	2.6
1575	-5.3	-59.7	16.6	168.0	-33.5	161.7	-19.6	-26.0	2.5
1600	-5.4	-58.5	16.5	163.9	-33.6	157.5	-16.7	-6.0	2.5
1700	-5.5	-53.7	15.8	149.3	-33.6	148.3	-9.0	3.6	2.3
1800	-5.3	-50.3	14.7	136.8	-34.2	142.5	-5.7	-2.8	2.2
1900	-5.1	-48.0	13.4	130.0	-35.1	139.6	-4.0	-9.6	2.3
2000	-4.9	-46.3	12.7	123.9	-35.8	138.6	-3.0	-15.0	2.1

Table 3. MAX2657 Typical Noise Parameters (V_{CC} = 2.85V, T_A = +25°C)

FREQUENCY (MHz)	F _{MIN} (dB)	Γ _{OPT}	Γ _{OPT} ANGLE	R _N (Ω)
1550	0.68	0.44	47.7	8.39
1560	0.68	0.44	48.1	8.38
1570	0.68	0.44	48.3	8.37
1575	0.68	0.44	48.5	8.36
1580	0.68	0.44	48.6	8.36
1590	0.68	0.44	48.9	8.35
1600	0.68	0.44	49.2	8.34

Table 4. MAX2658 Typical Noise Parameters (V_{CC} = 2.85V, T_A = +25°C)

FREQUENCY (MHz)	F _{MIN} (dB)	Γ _{OPT}	Γ _{OPT} ANGLE	R _N (Ω)
1550	0.68	0.28	88.0	4.48
1560	0.68	0.28	88.4	4.48
1570	0.68	0.28	88.8	4.48
1575	0.68	0.28	89.0	4.48
1580	0.68	0.28	89.2	4.48
1590	0.69	0.28	89.6	4.47
1600	0.69	0.28	90.0	4.47

GPS/GNSS Low-Noise Amplifiers

Chip Information

PROCESS: SiGe BiCMOS

Package Information

For the latest package outline information and land patterns, go to www.maxim-ic.com/packages.

PACKAGE TYPE	PACKAGE CODE	DOCUMENT NO.
6 WLP	W61B1+1	21-0217

Maxim cannot assume responsibility for use of any circuitry other than circuitry entirely embodied in a Maxim product. No circuit patent licenses are implied. Maxim reserves the right to change the circuitry and specifications without notice at any time.

8 _____ **Maxim Integrated Products, 120 San Gabriel Drive, Sunnyvale, CA 94086 408-737-7600**